

SYSTEMATIC QUALITY

Junction boxes

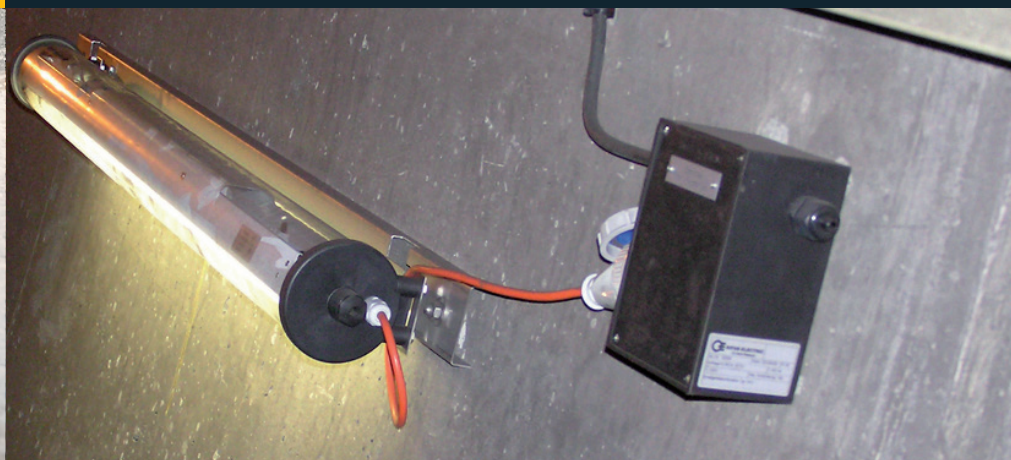

Catalogue



Introduction

Pages 3-6

Webshop



Page 3

Technical notes



Pages 4-6

Hard rubber junction boxes type 1010 -3020

Pages 7-9

Type 1010



Page 7

Type 1212



Page 7

Type 1616

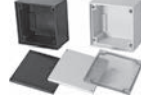

Page 8

Type 1812

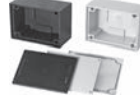

Page 8

Type 2516



Page 9

Type 3020



Page 9

Hard rubber junction boxes type 3800 -7900

Universal connection and branching sleeves

Pages 10-13

Type 3800



Page 10

Type 3900



Page 10

Type 7800



Page 11

Type 7900



Page 11

Accessories



Page 12

Universal connection and branching sleeves



Page 13

Polyester junction and distribution boxes GFK type 1616-3018

Pages 14-16

Type 1616



Page 14

Type 2516



Page 15

Type 3018



Page 15

Accessories



Page 16

Various junction boxes

Applications

Pages 17-19

Various junction boxes



Page 17

Applications



Pages 18-19

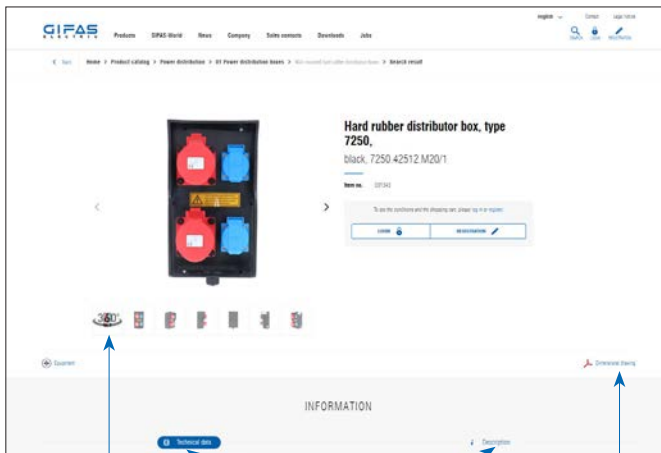

360° images

Technical data/Description

Technical drawing/
information



The GIFAS website offers an extensive assortment for customers from trade and industry. The simple and customer-friendly interface quickly takes you to the desired product. Take the plunge and have direct access to more than 3'000 articles.

► Go to the website: www.gifas.ch

Your benefits

- download CAD drawings, electrical diagrams and other product information
- customised solutions
- practical examples
- product documentation

GIFAS-World

We will guide you through the GIFAS World on our website with animated situations at the workplace and at home. Our advanced product solutions are used in the most diverse areas - roads, railways, hospitals, sewage plants or wherever electricity, light and safety are required. The areas of application are numerous and varied. Let us inspire you! Click on www.gifas.ch/world and immerse yourself in the all-embracing landscape of the GIFAS World.



Safety first

Junction boxes from GIFAS-ELECTRIC open up new possibilities for safe electrical installations and all around. Whether on uneven ground or in restricted conditions, whether in industry or in building construction, for interior or exterior applications – our boxes can be used anywhere, where power flows because...

...safety first!

Varied applications

- sewage plants
- chemical industry, galvanizing works
- tunnel construction, tunnels/caverns
- finishing industry
- road and garden construction
- food and luxury food industry
- mines, transport systems

...and much more!

Hard rubber junction boxes



- safety insulated
- no corrosion
- no condensation – even with significant temperature fluctuations
- weather, UV and ozone-proof
- strong seal (IP 65) against dust and water jets
- maintenance-free
- widely resistant to chemicals, therefore also suitable for the chemical industry and sewage plants
- shatterproof and impact-resistant
- maximal safety in fire conditions: self-extinguishing, halogen-free (no toxic gases)
- assembled according to your technical specifications
- individually equipable

Polyester junction boxes



- safety insulated
- impact-resistant
- UV resistant
- halogen free
- resistant to aging and temperature resistant
- resistant to oil and acid
- widely resistant to chemicals
- barely flammable, self-extinguishing
- with 4 exterior assembly and fixing points

Various junction boxes / casings



- assembled according to your specifications
- various dimensions, executions and materials available:
 - stainless steel V2A / V4A
 - polycarbonate
 - small polyester casings
 - ABS standard
- ATEX executions are available

Technical notes – perfect, systemised power branching



Casing

The casings have a technically matured design and offer maximum Material features quality. Ten casings are available in different sizes and shapes, and in the colours electric grey RAL 7035 and black.



Terminals

Only high quality connection and junction terminals are used for the installation.



Screwed cable glands

For installation there is a hand-picked range of equipment available with special Material features features. A strong impermeability (IP68) and resistance to chemical influences are key features of these screwed cable glands.

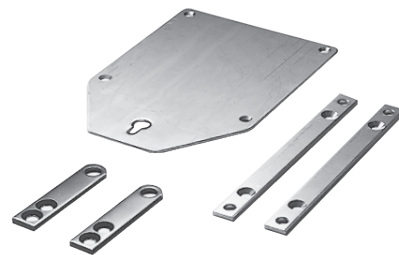

Accessories

The accessories available include mounting plates or brackets made from stainless steel (V2A/V4A) for uneven bases or where space is at a premium.

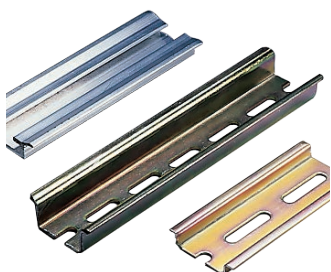

Rails

Standardised DIN rails are ideal for the easy and rapid installation of terminals or command and messaging equipment. Retrofitting or add-on installations are possible.



Labelling

An engraved or inscription plate is possible for clear identification of technical operating notes on request.

The notes given on this page relate to the solid rubber junction boxes. This information applies to fire-proof junction boxes (see Reg. 04A) in a limited way only.

With our system you can stay flexible

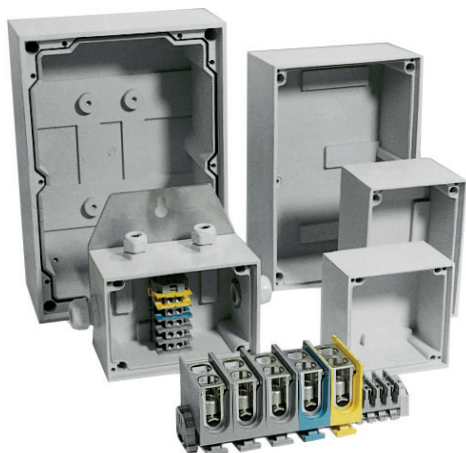

Mounting plate or bracket made from stainless steel
for simple and fast fitting.

V2A/V4A

Sealing groove, sealing part and rubber seal
guarantee a high protection category (IP 65).

IP65

Fitting holes outside the terminal area
for complete safety insulation.



Wall thickness from 7 to 15 mm
for use in extreme conditions.



Casing special mixture of butyl rubber
self-extinguishing and halogen-free.



Cover made of polycarbonate
self-extinguishing and halogen-free.
When using especially aggressive cleaning
and operating Material features we recommend using
covers in V2A/V4A versions (on request).



Temperature conductance (condensate formation)

Rubber in vulcanised form is a poor conductor of heat. The thick-walled design of all casings provides very good storage of the given temperature (inside and outside). The dew point (time when humid air condenses) is therefore only transferred very slowly towards the inside. The risk of moisture condensate forming on the inside is virtually excluded.

The notes given on this page relate to the solid rubber junction boxes. This information applies to fire-proof junction boxes (see catalogue 04A) in a limited way only.

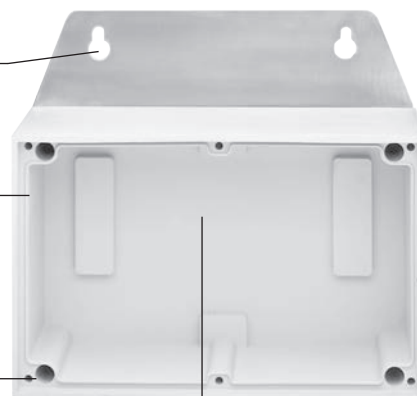

Type 1010

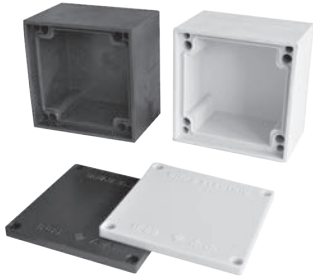

Technical Data

For cable-Ø up to.: 5×2.5 mm²
 External dimensions: 100×100×65 mm
 Internal dimensions: 83×83×52 mm
 IP rating: IP65

The following items indicate corresponding versions/configurations. The specific execution (placement of cable glands) is redrawn and executed case by case.

Item no		Cable glands	Terminal
light grey	black		
057997	058000	3×M16×1.5	no
057998	058001	4×M16×1.5	no
057999	058006	2×M20×1.5	no
✓ 058007	✓ 058008	Empty casing	

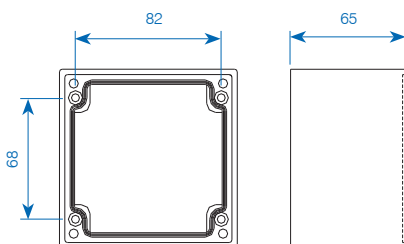

Type 1212

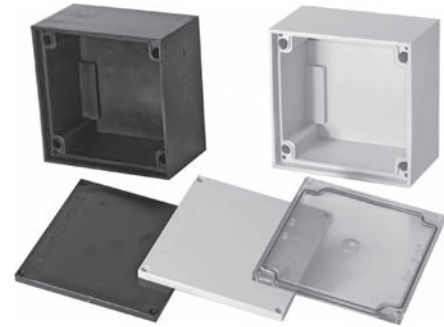

Technical Data

For cable-Ø up to.: 5×6 mm²
 External dimensions: 125×125×76 mm
 Internal dimensions: 108×108×64 mm
 IP rating: IP65

The following items indicate corresponding versions/configurations. The specific execution (placement of cable glands) is redrawn and executed case by case.

Item no		Cable glands	Terminal
light grey	black		
070201	070251	4×M16×1.5	3×6 mm ²
070202	070252	2×M20×1.5	5×2.5 mm ²
070203	070253	3×M20×1.5	5×6 mm ²
070204	070254	4×M20×1.5	5×6 mm ²
070205	070255	1×M25×1.5 / 2×M20×1.5	5×6 mm ²
070206	070256	1×M25×1.5 / 3×M20×1.5	5×6 mm ²
070207	070257	2×M25×1.5	5×6 mm ²
✓ 056764	✓ 056765	Empty casing incl. DIN Rail	

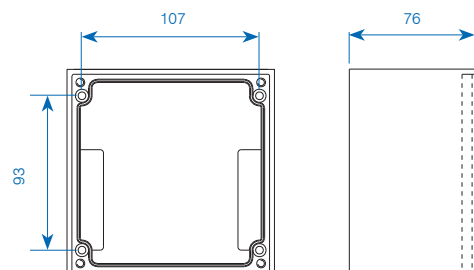

✓ from stock, offer subject to prior sale

Type 1616



Type 1812



Technical Data

For cable-Ø up to.: 5×16mm²
 External dimensions: 160×160×90mm
 Internal dimensions: 142×142×74mm
 IPrating: IP65

Technical Data

For cable-Ø up to.: 5×16mm²
 External dimensions: 180×125×90mm
 Internal dimensions: 157×107×74mm
 IPrating: IP65

The following items indicate corresponding versions/configurations. The specific execution (placement of cable glands) is redrawn and executed case by case.

The following items indicate corresponding versions/configurations. The specific execution (placement of cable glands) is redrawn and executed case by case.

Item no		Cable glands	Terminal
light grey	black		
070211	070261	3×M20×1.5	5×6mm ²
070212	070262	4×M20×1.5	5×6mm ²
070213	070263	6×M20×1.5	5×6mm ²
070215	070265	3×M25×1.5	5×6mm ²
070216	070266	4×M25×1.5	5×10mm ²
070217	070267	2×M32×1.5	5×10mm ²
070218	070268	2×M32×1.5 / 2×M20×1.5	5×16mm ²
070219	070269	2×M32×1.5 / 2×M25×1.5	5×16mm ²
✓ 056766	✓ 056767	Empty casing incl. DIN Rail.	

N° art.		Cable glands	Terminal
light grey	black		
070221	070271	3×M20×1.5	5×6mm ²
070222	070272	4×M20×1.5	5×6mm ²
070223	070273	2×M25×1.5	5×6mm ²
070224	070274	3×M25×1.5	5×6mm ²
070225	070275	2×M32×1.5	5×16mm ²
070226	070276	2×M25×1.5 / 2×M20×1.5	5×10mm ²
070227	070277	2×M25×1.5 / 3×M20×1.5	5×16mm ²
✓ 056768	✓ 056769	Empty casing incl. DIN Rail	

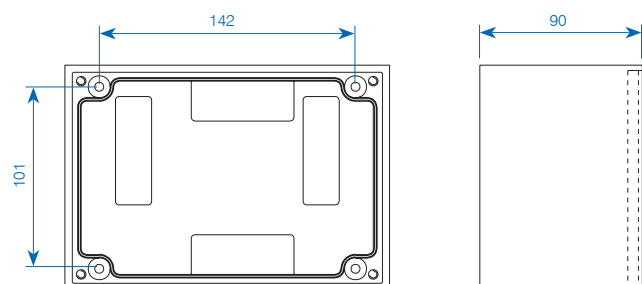
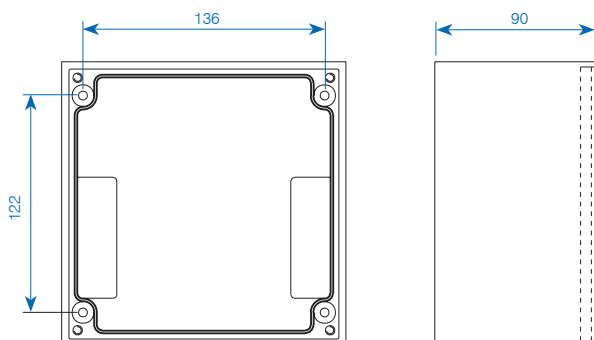

✓ from stock, offer subject to prior sale

Type 2516



Technical Data

For cable-Ø up to.: 5×25 mm²
 External dimensions: 250×160×90 mm
 Internal dimensions: 229×141×74 mm
 IP rating: IP 65

The following items indicate corresponding versions/configurations. The specific execution (placement of cable glands) is redrawn and executed case by case.

Item no		Cable glands	Terminal
light grey	black		
070231	070281	6×M20×1.5	18×2.5 mm ²
070233	070283	3×M25×1.5	5×10 mm ²
070234	070284	4×M25×1.5	5×10 mm ²
070235	070285	5×M25×1.5	5×16 mm ²
070237	070287	3×M32×1.5	5×16 mm ²
070238	070288	4×M32×1.5	5×35 mm ²
070239	070289	2×M40×1.5	5×35 mm ²
070240	070290	3×M40×1.5	5×35 mm ²
✓ 056770	✓ 056771	Empty casing incl. DIN Rail	

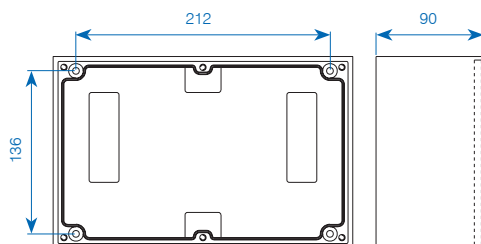

Type 3020



Technical Data

For cable-Ø up to.: 5×35 mm²
 External dimensions: 300×200×110 mm
 Internal dimensions: 281×182×94 mm
 IP rating: IP 65

The following items indicate corresponding versions/configurations. The specific execution (placement of cable glands) is redrawn and executed case by case.

Item no		Cable glands	Terminal
light grey	black		
051060	051063	3×M32×1.5	5×35 mm ²
051061	051065	2×M50×1.5	5×70 mm ²
051062	051066	10×M20×1.5	10×6 mm ²
✓ 051072	✓ 051073	Empty casing incl. DIN Rail	

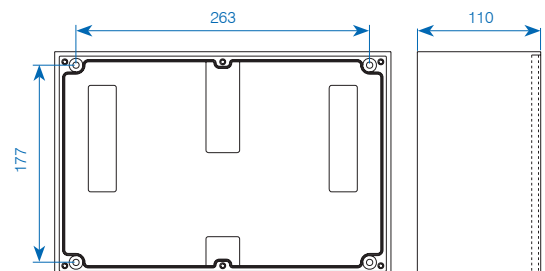

✓ from stock, offer subject to prior sale

Type 3800



Type 3900



Technical Data

For cable-Ø up to.: 5×50 mm²
 External dimensions: 360×250×133 mm
 Internal dimensions: 327×220×106 mm
 IP rating: IP 65

Technical Data

For cable-Ø up to.: 5×50 mm²
 External dimensions: 360×250×173 mm
 Internal dimensions: 327×220×144 mm
 IP rating: IP 65

The following items indicate corresponding versions/configurations. The specific execution (placement of cable glands) is redrawn and executed case by case.

The following items indicate corresponding versions/configurations. The specific execution (placement of cable glands) is redrawn and executed case by case.

Item no		Cable glands	Terminal
light grey	black		
051067	051070	4×M40×1.5	5×70 mm ²
051069	051071	2×M63×1.5	5×120 mm ²
✓ 051074	✓ 051077	Empty casing incl. DIN Rail	

Item no		Cable glands	Terminal
light grey	black		
109006	081669	Empty casing incl. DIN Rail	

The casing Type 3900 has a greater installation depth than Type 3800 (+40mm). It is used for special requirements such as all cable glands in the same side wall, terminals installed at different heights, etc.

For special applications we recommend using a mounting plate to fit series Type 3800 and Type 3900 (see page 12).

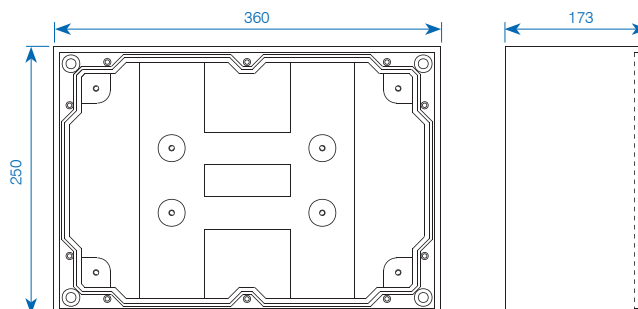
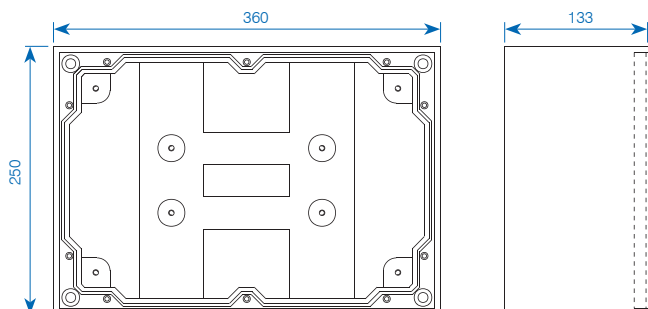

✓ from stock, offer subject to prior sale

Type 7800/Type 7900



Technical Data

Type 7800

For cable-Ø up to.: 5×95 mm²
 External dimensions: 500×360×133 mm
 Internal dimensions: 447×327×106 mm
 IP rating: IP 65

Type 7900

For cable-Ø up to.: 5×95 mm²
 External dimensions: 500×360×173 mm
 Internal dimensions: 447×327×144 mm
 IP rating: IP 65

The following items indicate corresponding versions/configurations. The specific execution (placement of cable glands) is redrawn and executed case by case.

Type 7800

Item no		Cable glands	Terminal
light grey	black		
051079	051082	4×M50×1.5	5×120 mm ²
051080	051083	1×cable glands special cable Ø46-60 mm) 4×M50×1.5	5×120 mm ²
051081	051085	10×M32×1.5	5×240 mm ²
051086	✓ 051088	Empty casing incl. DIN Rail	

Type 7900

Item no		Cable glands	Terminal
light grey	black		
109007	073740	Empty casing incl. DIN Rail and mounting plate	

Type 7800

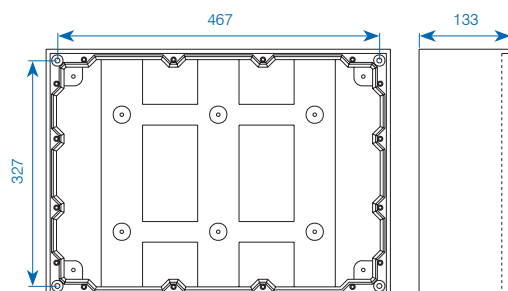

Type 7900 execution with door and lock



The casing type 7900 has a larger installation depth than type 7800 (+40 mm). It is used for special requirements such as all cable glands in the same side wall, terminals installed at different heights, etc.

For special applications we recommend using a mounting plate to fit series type 7800 and type 7900 (see page 12). Versions with door and lock are available on request.

The following items indicate corresponding versions/configurations. The specific execution (placement of cable glands) is redrawn and executed case by case.

Item no		Cable glands	Terminal
light grey	black		
109008	108999	Empty casing incl. DIN Rail, door and mounting plates	

Type 7900

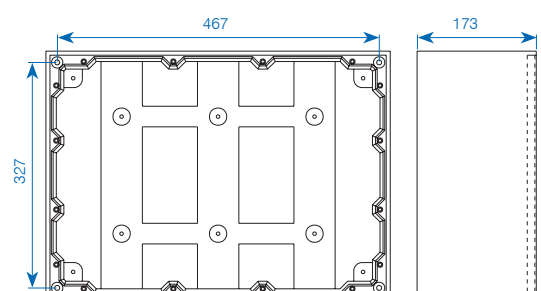

✓ from stock, offer subject to prior sale

Mounting plates / Mounting brackets

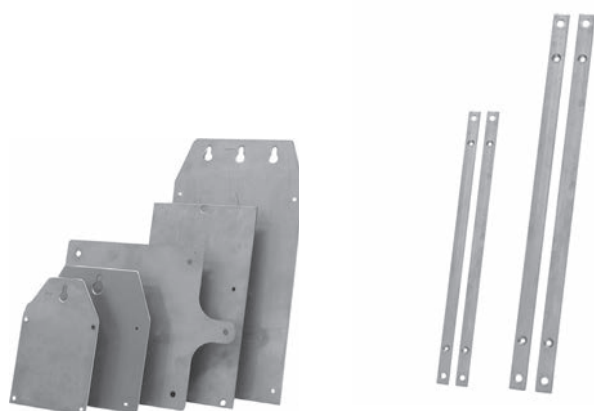

Mounting plates

Solid steel plates which can be mounted all-over onto the rear socket wall. The top of the mounting plate is protruding and is provided with one, two or three fixing holes (large «key» holes).

=> For complex mounting conditions such as shafts, tight spaces, etc.

Item no	for Type	Version
✓ 058205	1010	square, rust-free, A2
✓ 052787	1212	square, rust-free, A2
✓ 052788	1616	square, rust-free, A2
✓ 052789	1812	diagonal, rust-free, A2
✓ 052785	1812	vertical, rust-free, A2
✓ 052790	2516	diagonal, rust-free, A2
✓ 052792	2516	vertical, rust-free, A2
✓ 049943	3020	diagonal, rust-free, A2
✓ 050917	3020	vertical, rust-free, A2
✓ 040119	3800/3900	diagonal, rust-free, A2

Mounting brackets

Mounting brackets which can be mounted on the left and right side across the casing rear wall. The top and the bottom of the fitting brackets are protruding and are provided with generous mounting holes.

=> For a correct and permanent installation with 4 mounting holes

Item no	for Type	Version
✓ 178419	diverse	short, rust-free, V4A
✓ 058206	1010	long/diagonal, rust-free, A2
✓ 056089	1212/1812	long/diagonal, rust-free, A2
✓ 056090	1616/2516	long/diagonal, rust-free, A2
✓ 056091	1812	long/vertical, rust-free, A2
✓ 056092	2516	long/vertical, rust-free, A2
✓ 049691	3020	long/diagonal, rust-free, A2
✓ 049689	3020	long/vertical, rust-free, A2
✓ 032555	3800/3900	long/diagonal, rust-free, A2
✓ 032553	3800/7800	vertical/diagonal, rust-free, A2

✓ from stock, offer subject to prior sale

Mounting plates punched / Mounting rings



Mounting plates, punched

Item no	for Type
✓ 011411	3800 / 3900
✓ 019877	7800 / 7900

Mounting rings

Item no		Size	Core hole mm	Height mm
black	light grey	inside		
✓ 056834	✓ 056826	M16×1.5	19	12
✓ 056837	✓ 056828	M20×1.5	24	12
✓ 056838	✓ 056829	M25×1.5	29	13
✓ 056839	✓ 056831	M32×1.5	36	13
✓ 056840	✓ 056832	M40×1.5	44	15
✓ 056841	✓ 056833	M50×1.5	55	15
✓ 030466	✓ 030465	M63×1.5	67	15

Installation instruction

- 1st step: degrease junction box properly (with nitro diluter)
- 2nd step: drill a whole for the mounting ring (Ø acc. to chart, i.e. M16 = 19mm)
- 3rd step: paste mounting ring in (superglue Loctite type 406, caution: sticks within a few seconds)
- 4th step: fix the mounting ring by hammer finish immediately
- 5th step: assemble the cable gland

Item no.	Designation
✓ 026610	Loctite 406, superglue

Universal connection and branching sleeves

Universal connection and branching sleeves



Scope of delivery



Technical Data

Use:	Soil or outdoor area
Dimensions:	
– Item no. 206290:	170×72 mm
– Item no. 197983:	280×100 mm
Material:	Polypropylene black
Screw connection:	Cover made of polypropylene
Cable receptacle:	
– Item no. 206290:	4×5 - 14 mm
– Item no. 197983:	4×7 - 25 mm
Strain relief:	Mechanically via the cable grommet after insertion
Tensile stress:	min. 80 N/mm
Temperature range:	-30°C to +65°C
Test:	IP68, IM22
Electronics:	1 kV, ÖVE
Test number:	VAAE 36221

Item no.	Designation
✓ 206290	Connection sleeve Ø 170 mm×72 mm with 4 inlets Ø 5 - 14 mm
✓ 197983	Connection sleeve Ø 280 mm×100 mm with 4 inlets Ø 7 - 25 mm

Product features

These universal connection and branching sleeves were especially developed to provide simple and absolutely reliable protection for telecommunication and electrical applications. They can be installed outdoors, in pits and below ground, can be opened and reused as required and are provided with protection category IP68. The sleeves basically consist of only 3 parts: sleeve body, rubber end cap and cover. Cable ties, lubricant and a cutter are enclosed and guarantee problem-free processing of the sleeve without additional tools.

✓ from stock, offer subject to prior sale

Glass fibre reinforced polyester junction and distribution boxes

Besides our approved hard rubber product range we are able to fulfill highest chemical and mechanical demands, especially for such systems as in tunnels, in civil engineering, and in chemical and petrochemical industry.

Junction boxes GREY, FE05

Design approved to IP66/68

Along to Test Report APM Technica: APM_BE_3301389 water and dust in accordance with DIN EN 60529:2014

As a result of the higher protection category and the certification according to DIN 4102 Part, the boxes are ideal for adaptive, lane and safety lighting, especially in the national road network and tunnels - individual equipment to customer requirements possible!

Special features

- safety insulated
- impact-resistant
- UV resistant - halogen free
- resistant to aging and temperature resistant
- resistant to oil and acid
- widely resistant to chemicals
- with 4 exterior assembly and fixing points
- max. equipment: screw terminals up to 35mm²

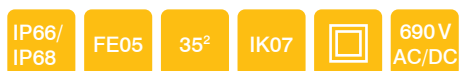

Technical Data FE05

Specification box type 1616 FE05

- junction box polyester glass fiber reinforced
- colour: grey RAL 7035
- protection category: IP68
- W×H×P: 160×160×100 mm

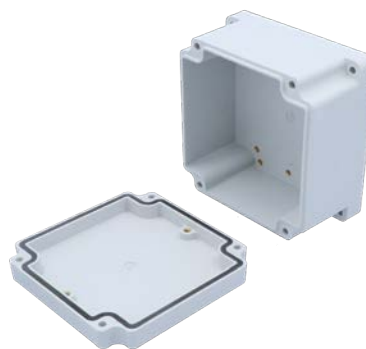

TBA 1616 – 160×160×100 mm / 5×16 mm²
Item no.: 205672

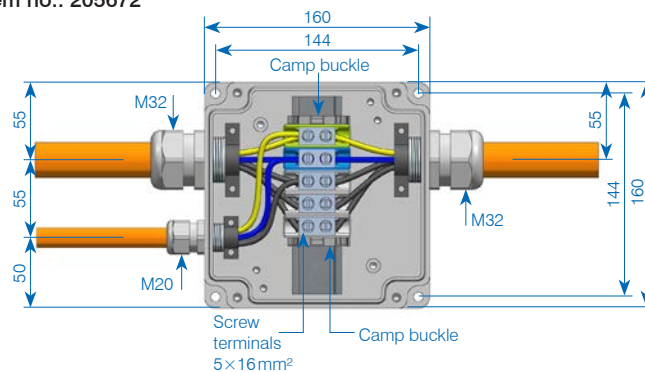

TBA 1616 – 160×160×100 mm / 7×10 mm²
Item no.: 205673

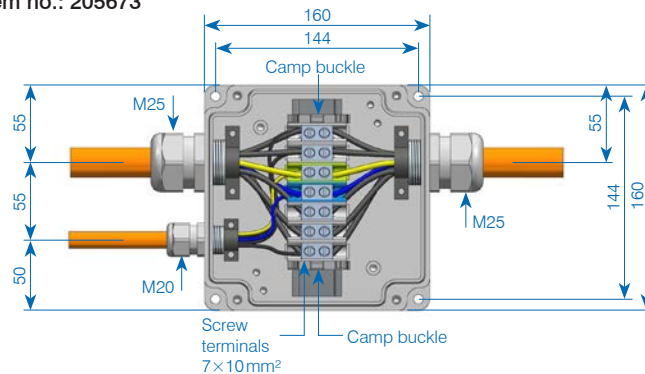

Polyester junction and distribution boxes GFK type 2516 and 3018

Technical Data FE05

Specification box type 2516 FE05

- junction box polyester glass fiber reinforced
- colour: grey RAL 7035
- protection category: IP66
- W×H×P: 250×160×100mm



TBA 2516 – 250×160×100mm/5×16mm²
Item no.: 205670

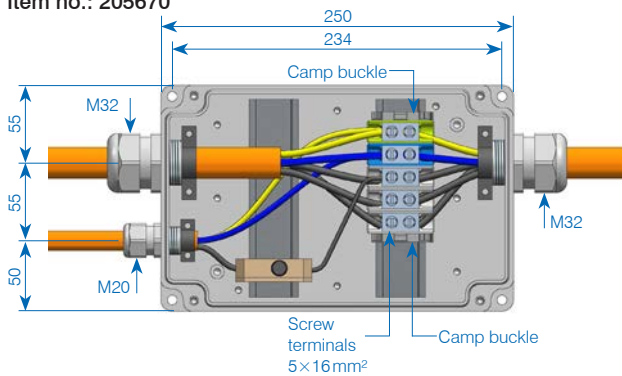

TBA 2516 – 250×160×100mm/7×16mm²
Item no.: 205671

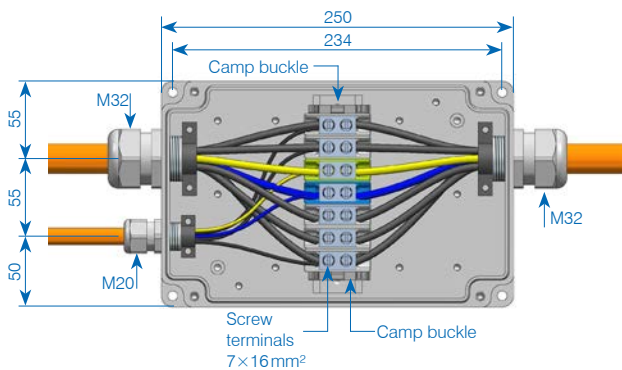

Technical Data FE05

Specification box type 3018 FE05

- junction box polyester glass fiber reinforced
- colour: grey RAL 7035
- protection category: IP66
- W×H×P: 300×180×100mm



TBA 3018 – 300×180×100mm/7×16mm²
Item no.: 189926

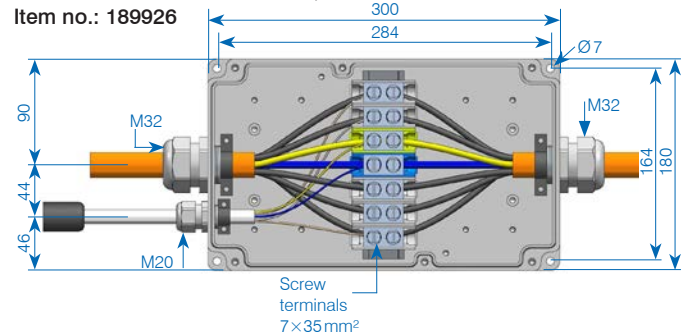

TBA 3018 – 300×180×100mm/7×16mm²
Item no.: 189883

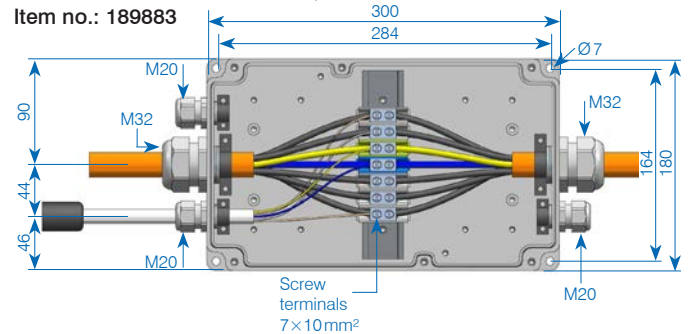

TBA 3018 – 300×180×100mm/7×16mm²
Item no.: 189885

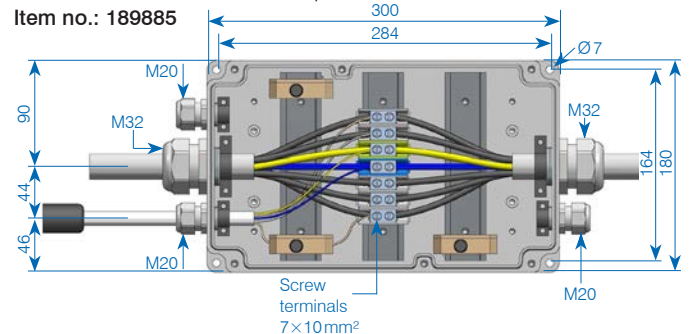

Mounting plates and brackets

A large number of different mounting plates and brackets are available for quick and easy installation of the junction boxes on ducts, tunnel ceilings or mounting supports. It goes without saying that individual special solutions are possible.

Material in V4A stainless steel 14571 or as according to customer requirements.

Mounting plate, crosswise, V4A stainless steel for type 1616 boxes ✓Item no.: 207053

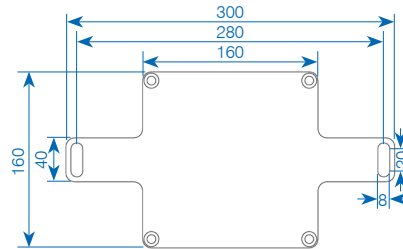

Mounting plate, crosswise, V4A stainless steel for boxes type 2516 ✓Item no.: 207052

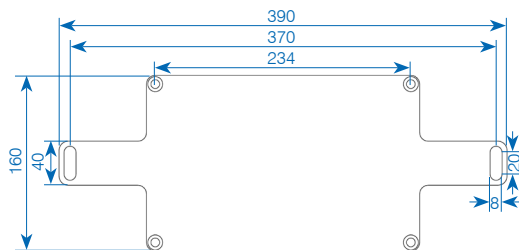

Mounting plate, vertical, V4A stainless steel for boxes type 2516 Item no.: 205559

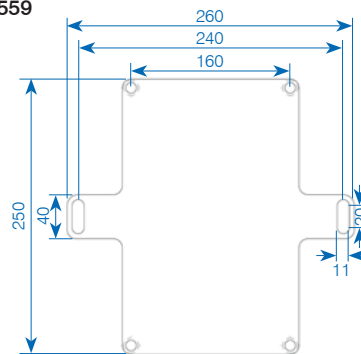

Mounting plate, crosswise, V4A stainless steel for boxes type 3018 ✓Item no.: 189869

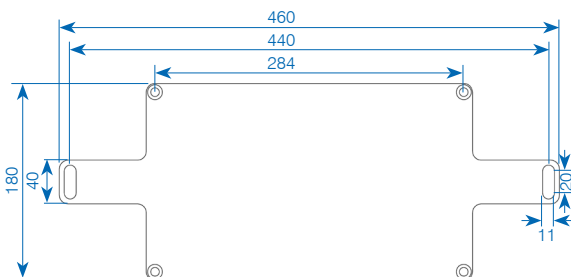

Mounting bracket, V4A stainless steel for boxes type 3018 Item no.: 206819

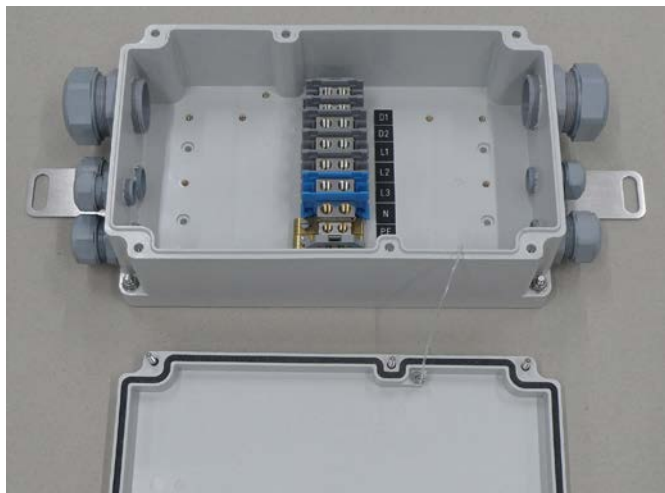
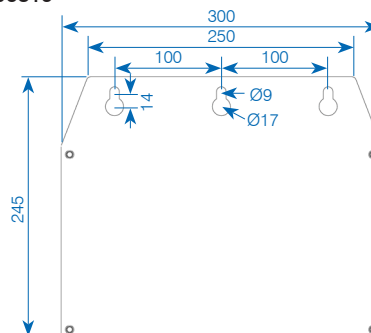

Junction box type 3018 in FE05 with through-wiring DALI

✓ from stock, offer subject to prior sale

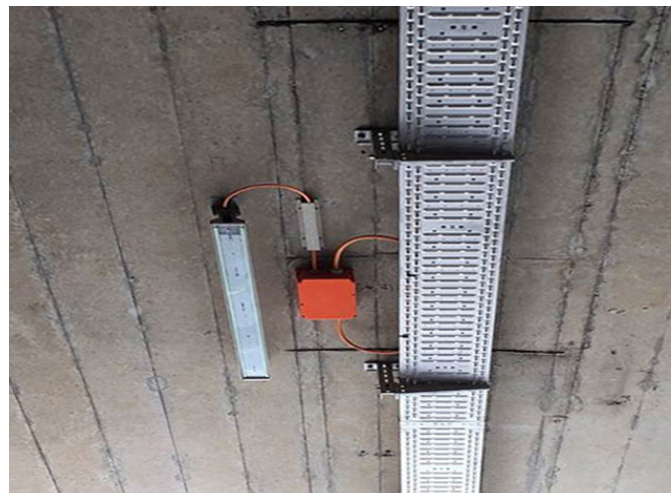

Typical example of an installation with adaptive lighting for emergency power system in FE180/E30

Stainless steel industry V2A / V4A

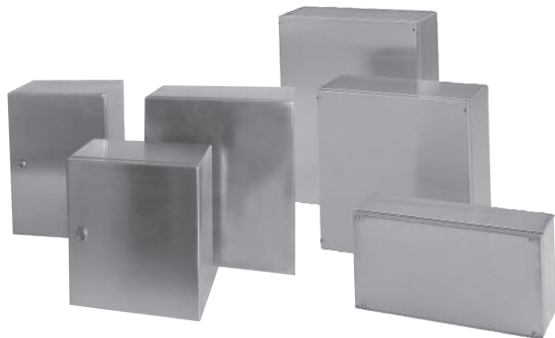

- casings with concealed hinge and lock
- standard casing for hygiene areas
- IP rating up to IP69K (on request)
- equipped/assembled according to your technical specifications

Polycarbonate / ABS standard

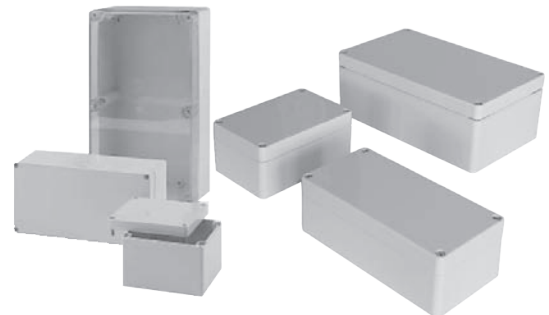

- light plastic casing for industrial applications
- Polycarbonate casing with standard or transparent cover
- ABS casing with standard cover
- optional EMV version (coated)
- equipped/assembled according to your technical specifications

Polyester casings

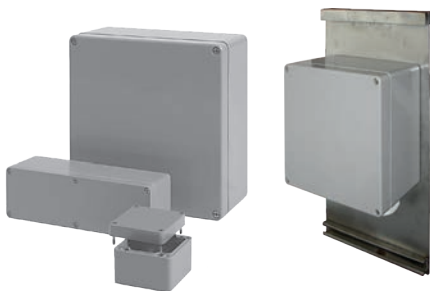

- polyester casing, glass fiber reinforced, for installations et al.
- mounting options for mounting rails and mounting plates

Explosion-proof casings / Explosion-proof equipment



- aluminium, polyester and stainless steel
- authorized for zones 1, 2, 21, 22 (ATEX/IEC Ex II 2G, Ex II 2D tD A21)
- equipped/assembled according to your technical specifications

small polyester casings



- casing systems with concealed exterior hinges
- standard execution or with inspection glass
- equipped/assembled according to your technical specifications

Fire-proof junction boxes



- with preservation of functionality E30 conforming to DIN 4102, part 12
- certified /with test protocol
- to protect life and property in the case of fire
- various dimensions on request
- assembled according to your technical specifications
- individually equipable

Of all casings various dimensions are available. We would like to advise you on your individual application!



Sewage plants Simple – Fast – Durable

Connection of pumps, indicator and monitoring units: With our hard rubber junction boxes you are flexible in any installation! Rust-free, UV-resistant, and resistant to most chemical substances. For use in the toughest conditions!



Industry Your control and distribution problem – our expertise

Various casing shapes and sizes give you the options you need. Sensitive controls or terminal strips for combining connection lines can be integrated into our junction boxes in an impact-proof and compact way.



National highways/road maintenance We'll keep you on the right track!

Connection and junction boxes for steering, control and maintenance. Individual component fitting conforming to the standards of the relevant road traffic office. Resistant to continually changing environmental and weather conditions.



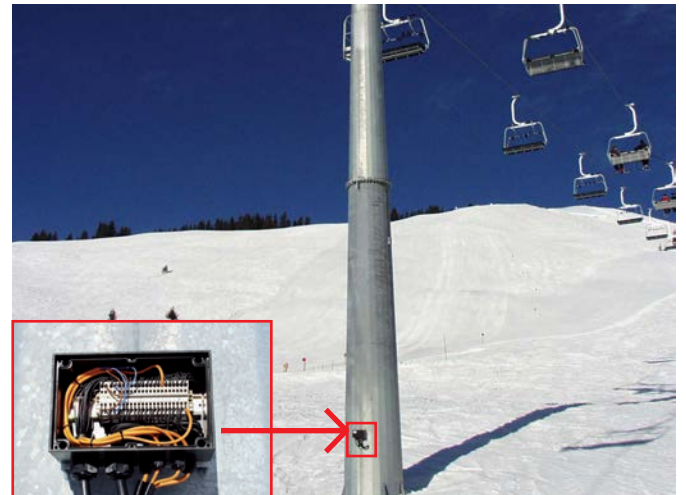
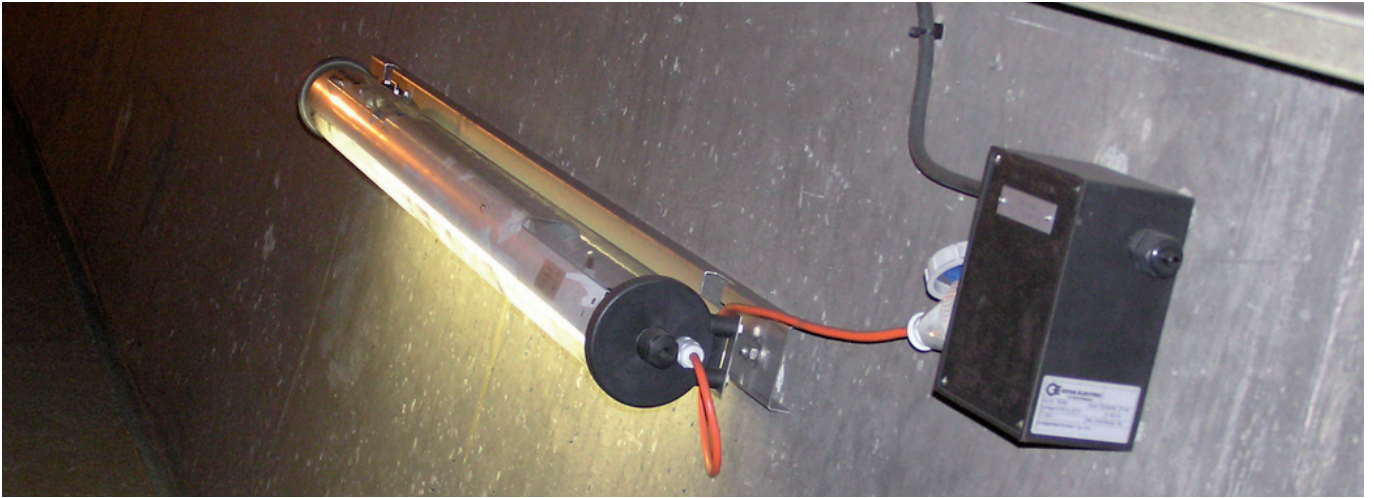

GET IN TOUCH WITH US

News about the assortment and specific solutions
you can find on our website:

www.gifas.ch

We reserve the right to make technical modifications. V 0621



GIFAS
ELECTRIC

GIFAS-ELECTRIC GmbH
Dietrichstrasse 2
CH-9424 Rheineck

+41 71 886 44 44
+41 71 886 44 49
info@gifas.ch
www.gifas.ch